

AT180Y
Digital Three-Phase
Multi function Meter
User's Manual
V1.1



Hangzhou Antin Electric Power Technology Co.

Declarations

All rights reserved, without the written permission of the company, any paragraph or chapter content in this manual shall not be excerpted, copied or reproduced or disseminated in any form, otherwise all consequences shall be borne by the violator.

All legal rights reserved.

The Company reserves the right to modify the product specifications described in this manual without prior notice. Before ordering, please contact our company or local agent for the latest specifications of this product.

Contents

Chapter 1 Product Overview	- 1 -
1.1 Product Introduction	- 1 -
1.2 Product Features	- 1 -
1.3 Product Parameters	- 2 -
Chapter 2 Technical Specifications	- 3 -
2.1 Technical Parameters	- 3 -
2.2 Wiring Diagram	- 5 -
2.3 Dimensions and installation drawings	- 6 -
Chapter 3 Operating Instructions	- 7 -
3.1 Key Description	- 7 -
3.2 Launch Interface	- 7 -
3.3 Battery Level Inquiry	- 8 -
3.3.1 Electricity parameter query	- 8 -
3.3.2 Electricity Parameter Inquiry	- 10 -
3.3.3 Other parameter inquiry(optional function)	- 11 -
3.4 User parameter settings	- 11 -

3.4.1 Power parameter setting	- 12 -
3.4.2 Communication parameter setting	- 13 -
3.4.3 Power zero setting	- 15 -
3.4.4 Backlight delay time setting	- 15 -
3.4.5 Parameter setting for open volume	- 16 -
3.4.6 Transmission parameter setting	- 19 -
3.4.7 User Password Setting	- 21 -
English correspondence table of digital tubes	- 22 -
After-sales service	- 23 -

Chapter 1 Product Overview

1.1 Product Introduction

This series of digital LCD three-phase multi-function meter adopts professional metering chip with industrial-grade microprocessor as the core to measure electric parameters such as voltage, current, power, power factor, frequency, forward and reverse bi-directional electric energy in the power grid, which has high cost performance. Embedded installation, simple wiring, small amount of engineering. Broken code liquid crystal display, easy to read the data. Widely used in electric power grid, automation control system, SCADA, DCS system, etc., help users save investment and use space.

1.2 Product Features

- Three-phase power parameter calculation
- Modular design for flexible configuration of individual functions
- Adjustable voltage-current ratio
- Parameter setting password lock, power off permanent save
- Support RS-485 communication, MODBUS-RTU protocol
- Adopt AC/DC dual-purpose power supply, high and low voltage isolation
- Segmented LCD
- Easy installation and wiring

1.3 Product Parameters

Measurement and metrology	
Voltage	Phase voltage, line voltage
Current	Three-phase current
Active power	Split-phase and total active power
Reactive power	Split-phase and total reactive power
Apparent power	Split-phase and total apparent power
Power factor	Split-phase and total power factor
Frequency	45-65Hz
Electricity metering	
Active energy	Forward/reverse active energy
Reactive energy	Forward/reverse reactive energy
Communication function	
Communication protocols	MODBUS-RTU
Communication method	RS485

Chapter 2 Technical Specifications

2.1 Technical Parameters

Technical Parameters		Norm	
Applicable networks		Three-phase four-wire, three-phase three-wire	
Operating power	Voltage range	AC/DC85~265V; DC18V~72V (selectable)	
	Power wastage	<2W	
Accuracy Class		Reactive power 1.0 level, the rest 0.5 level	
Input	Voltage	Rating	AC 100V、220V、400V
		Power wastage	<0.4VA/Phase
		(electrical) impedance	$\geq 200k\Omega$
	Current	Rating	AC 5A(0.02A-6A)
		Power wastage	<0.2VA/phase
		(electrical) impedance	$\geq 0.1\Omega$

	Frequency	45Hz~65Hz
	Switching input	Dry Contact Input, Opto-Isolated
Output	Switching output	Relay output; any power alarm can be set, default remote control
	Analog output	0~20mA/0~5V (Can be set arbitrarily)
	Digital communication interface	RS485/Modbus-RTU
	Pulse output	1~2 power pulses, four-quadrant power metering
Environment	Temperature	Operating temperature: -20°C~55°C Store: -25°C~70°C
	Humidity	≤90%RH, Non-condensing, non-corrosive gas locations
	Altitude	≤2500m
EMC electromagnetic compatibility test	Electrostatic discharge immunity test	GB/T 17626.2-2006: Test level 4, test voltage 8kV
	Radio Frequency Electromagnetic Field Immunity Test	GB/T 17626.3-2006: Test level 3, test field strength 10V/m
	Rapid transient pulse group test	GB/T 17626.4-2008: Test level 2, current voltage 1kV, other 500V
	Surge (shock) immunity test	GB/T 17626.5-2008: Test level 4, test voltage 4kV
	Conducted Nuisance	GB/T 17626.6-2008: Test level 3, test

	Immunity Test for RF Field Induction	field strength 10V/m
	Immunity tests for voltage dips, short-term interruptions and voltage variations	GB/T 17626.11-2008: Current and voltage test error qualified
	Shock wave immunity test	GB/T 17626.12-1998: Class B ITE test, pass

2.2 Wiring Diagram

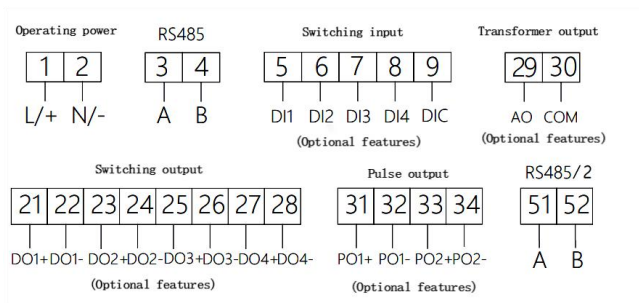

Three-phase four-wire terminal wiring diagram ▼

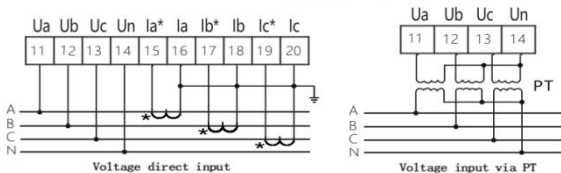

Three-phase three-wire terminal wiring diagram ▼

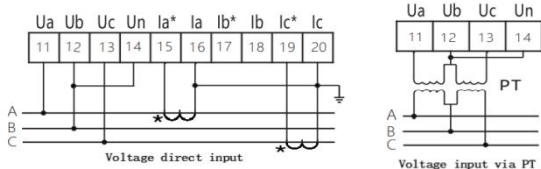



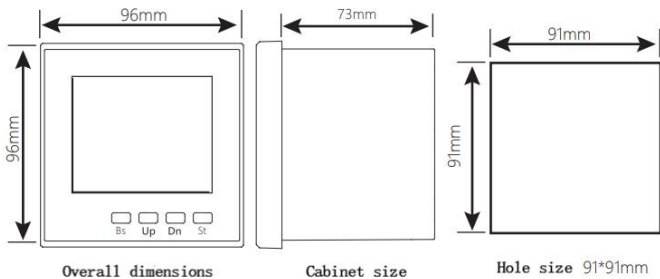

2.3 Dimensions and installation drawings



Chapter 3 Operating Instructions

3.1 Key Description

 <p>Bs</p>	<p>Bs key: Returns to the previous menu level. During parameter setting, if in the last level menu, it is used as a shift key to move the blinking bit.</p>
 <p>Up</p>	<p>Up key: View the previous screen display of the power, setup, select the previous option of the same level of the menu or type in the value of the value of the incremental value.</p>
 <p>Dn</p>	<p>Dn key: View the next screen display of the power, setup when you select the next option in the same level menu or type in the value when the value decreases.</p>
 <p>St</p>	<p>St key: enter the next level menu. In the parameter setting, if it is in the last level menu, it will be used as save and return to the upper - level menu; when the current menu is the password input menu, it will judge whether the password is correct or not, if it is correct, it will enter the next - level menu, otherwise, it will return to the upper - level menu.</p>

3.2 Launch Interface

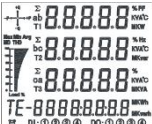
	<p>The startup interface displays all the segment codes on the full screen, and the interface stays for 1s, which is used to detect whether the LCD screen can display normally.</p>
--	--

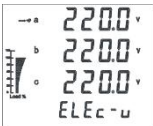
	<p>After the startup interface completes the self-test, it enters the three-phase voltage display interface and acts as the main interface to display the meter power parameters.</p>
---	---

3.3 Battery Level Inquiry

Under the initial display interface, through "Up" and "Dn" keys, select the power interface, electric energy interface or other extended parameter interface to be displayed, and after the query is completed, return to the initial interface through "Bs" key. When the query is completed, use "Bs" key to return to the first interface.

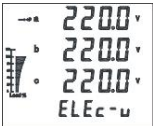
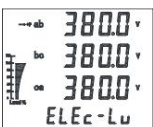
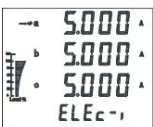

3.3.1 Electricity parameter query

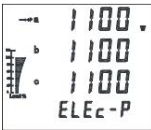
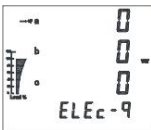
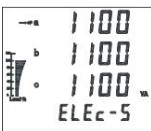
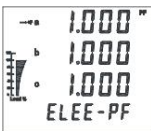
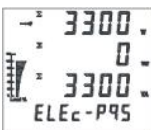
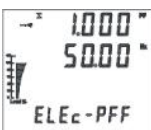
	<p>In the initial interface state, through the "Up" and "Dn" keys, select the interface that needs to display the power parameter, and in the case of three-phase four-wire system, the three-phase voltage interface is the first interface.</p>
	<p>Press "Dn" key to display the three-phase line voltage, and this interface is displayed by default for three-phase three-wire system.</p>
	<p>Press the "Dn" key to display the three-phase current.</p>

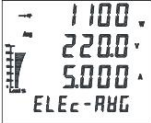
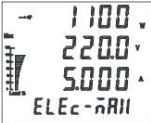

	<p>Press the "Dn" key to display the three-phase active power.</p>
	<p>Press the "Dn" key to display the three-phase reactive power.</p>
	<p>Press the "Dn" key to display the three-phase apparent power.</p>
	<p>Press the "Dn" key to display the three-phase power factor.</p>
	<p>Press "Dn" to display three-phase total active power, three-phase total reactive power and three-phase total apparent power.</p>
	<p>Press the "Dn" key to display the total three-phase power factor and system frequency.</p>

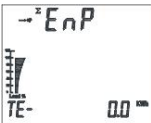
	<p>Press "Dn" key to display three-phase average active power, three-phase average voltage and three-phase average current.</p>
	<p>Press "Dn" key to display the maximum value of three-phase active power, three-phase voltage and three-phase current.</p>

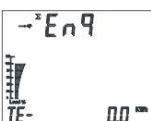
3.3.2 Electricity Parameter Inquiry

	<p>Under the interface of three-phase active power maximum, three-phase voltage maximum and three-phase current maximum, press "Dn" key to display the positive total active power.</p>
	<p>Press the "Dn" key to display the reverse total active energy.</p>
	<p>Press the "Dn" key to display the total positive reactive energy.</p>
	<p>Press the "Dn" key to display the reverse total reactive energy.</p>

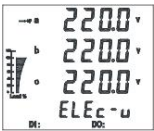
3.3.3 Other parameter inquiry (optional function)

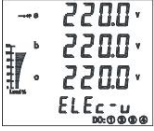
	<p>Meter with open-in open-out quantity function displays DIDO at the bottom of any parameter screen.</p>
	<p>Under any parameter interface, the left figure shows open in, indicating that the current 4-channel open in quantity is valid.</p>
	<p>Under any parameter interface, the left figure shows open out, indicating that the current 4-channel open out is valid.</p>

3.4 User parameter settings

In the initial display interface, press the "St" key, and then press the "Dn" key continuously to find the menu item of user setting, as shown in the following figure, press the "St" key to enter the user password. Input interface to complete the password input, through the "Up" key and "Dn" key for digital increase or decrease, through the "Bs" key for digital blinking shift, the factory initial password is The initial factory password is "0001".



	<p>In the initial interface, press the "St" key, and then press the "Dn" key continuously to find the user setting menu item.</p>
	<p>Press the "St" key to display the password input interface, as shown in the left figure, enter the correct setup parameter to enter the setup parameter interface, the factory initial password is 0001.</p>



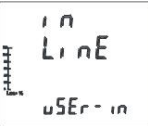
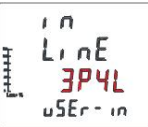
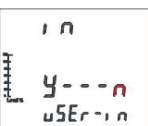

3.4.1 Power parameter setting

	<p>Enter the user parameter setting interface, press "Dn" key to find the power parameter setting menu item interface.</p>
	<p>Press the "St" key to display the electrical parameter setting option interface, use the "Up" and "Dn" keys to find the PT ratio setting menu item.</p>
	<p>Press the "St" key to display the PT ratio parameter setting interface, and set the desired PT ratio value (setting value: 1-5000) through the numeric increment/decrement keys and the "Bs" shift key.</p>
	<p>Press the "St" key to return to the electrical parameter setting option interface, and use the "Up" and "Dn" keys to find the CT ratio setting menu item.</p>

	<p>Press the "St" key to display the CT ratio parameter setting interface, and set the desired CT ratio value (setting value: 1-5000) through the numeric increment/decrement keys and the "Bs" shift key.</p>
	<p>Press the "St" key to return to the Electrical Parameter Setting Options screen, and use the "Up" and "Dn" keys to locate the Line System Setting menu item.</p>
	<p>Press the "St" key to display the line system parameter setting interface, and use the "Up" and "Dn" keys to set the desired line system value (setting options: 3P4L, 3P3L).</p>
	<p>After setting, press "St" key to confirm the setting, press "Bs" key continuously to select "y" blinking, and press "St" key to confirm the saving parameters. Press "Bs" key continuously to select "y" blinking, and press "St" key to confirm to save the parameter.</p>

3.4.2 Communication parameter setting

	<p>Enter the user parameter setting interface, press the "Dn" key to find the communication parameter setting menu item interface.</p>
	<p>Press the "St" key to display the communication parameter option screen, use the "Up" and "Dn" keys to find the communication address setting menu item.</p>

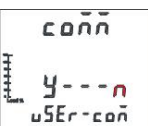

	<p>Press the "St" key to display the communication address setting interface, and use the "Up" and "Dn" keys to set the desired communication address value (setting value: 1-253).</p>
	<p>Press the "St" key to return to the communication parameter option interface, and use the "Up" and "Dn" keys to find the communication baud rate menu item.</p>
	<p>Press "St" key to display the baud rate setting interface, set the desired communication baud rate by "Up" and "Dn" keys (setting options: 4800/9600/19200). 19200).</p>
	<p>Press the "St" key to return to the communication parameter option interface, and use the "Up" and "Dn" keys to find the communication verification setting menu item.</p>
	<p>Press the "St" key to display the parity parameter setting interface, and set the required parity bit (setting value: no/even/odd) through the "Up" and "Dn" keys.</p>
	<p>After setting, press "St" to confirm the setting, press "Bs" continuously to select "y" blinking, and press "St" to confirm the saving parameters. Press "Bs" key continuously to select "y" blinking, and press "St" key to confirm the saving parameters.</p>

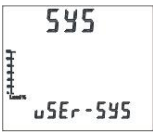
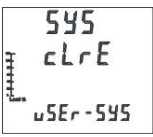
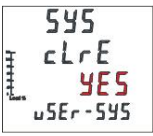
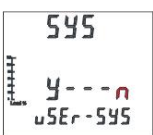
3.4.3 Power zero setting

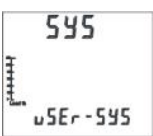

	<p>Enter the user parameter setting interface, press the "Dn" key to find the system parameter setting menu item interface.</p>
	<p>Press the "St" key to display the system parameter setting interface, and use the "Up" and "Dn" keys to find the menu item of power clearing.</p>
	<p>Press "St" key to display the interface of power zero setting, switch "yes" and "no" by "Up" and "Dn" keys, select "yes". Press "Up" and "Dn" to switch between "yes" and "no", select "yes".</p>
	<p>After setting, press "St" key to confirm the setting, press "Bs" key continuously to select "y" blinking, and press "St" key to confirm the saving parameters. Press "Bs" key continuously to select "y" blinking, and press "St" key to confirm to save the parameter.</p>

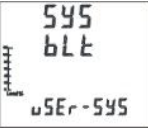
3.4.4 Backlight delay time setting

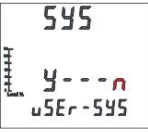
	<p>Enter the user parameter setting interface, press the "Dn" key to find the system parameter setting menu item interface.</p>
---	---

	<p>Press the "St" key to display the system parameter setting interface, and use the "Up" and "Dn" keys to find the backlight delay menu item.</p>
	<p>Press "St" key to display the backlight delay time setting interface, the default delay time is 60S, through the "Up" and "Dn" keys, set the desired backlight delay time (when the time is set to 0, the backlight is always on). (When the time is set to 0, the backlight is always on).</p>
	<p>After setting, press "St" key to confirm the setting, press "Bs" key continuously to select "y" blinking, and press "St" key to confirm the saving parameters. Press "Bs" key continuously to select "y" blinking, and press "St" key to confirm to save the parameter.</p>

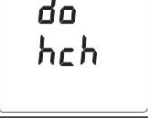
3.4.5 Parameter setting for open volume

	<p>Enter the user parameter setting interface, press the "Dn" key, and find the menu item interface of parameter setting for open quantity.</p>
	<p>Press the "St" key to display the open volume setting options screen, and use the "Up" and "Dn" keys to find the upper limit return parameter setting menu item.</p>
	<p>Press the "St" key to display the upper limit return parameter setting interface, and set the upper limit return value by using the "Up" and "Dn" keys (the default is 0.9: i.e. the action value is 0.9 times of the setting value). 0.9 times of the set value).</p>





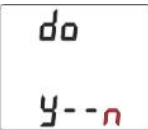

	<p>Press the "St" key to return to the open volume setting option interface, and use the "Up" and "Dn" keys to find the lower limit return parameter setting menu item.</p>
	<p>Press "St" key to display the lower limit return parameter setting interface, through the "Up" and "Dn" keys, set the lower limit return value (default is 1.1: that is, the action value is 1.1 times of the setting value). (default is 1.1: the action value is 1.1 times of the setting value).</p>
	<p>Press the "St" key to return to the output setting options screen, and use the "Up" and "Dn" keys to locate the DO1 output setting menu item.</p>
	<p>Press the "St" key to display the DO1 output parameter setting interface, the default is DO1 output parameter channel selection menu item.</p>
	<p>Press the "St" key to display the DO1 parameter channel setting interface, and set the desired channel parameter through the "Up" and "Dn" keys (setting value: UH/UL/IH/IL etc. optional; no for remote control output). IL etc.; no is remote control output).</p>
	<p>Press the "St" key to return to the DO1 output parameter setting interface, and use the "Up" and "Dn" keys to find the DO1 parameter setting menu item.</p>

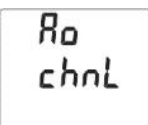
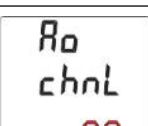
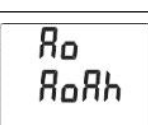
<p>The LCD display shows the text 'do' on the first line, 'dEL 1' on the second line, and '2500' on the third line. The '2500' is highlighted in red.</p>	<p>Press the "St" key to display the parameter setting option interface, use the "Up" and "Dn" keys to set the parameters of DO1 channel (Setting value: change based on the default parameter value, such as (Setting value: change based on the default parameter value, e.g., the upper limit value of voltage is 250V by default).</p>
<p>The LCD display shows the text 'do' on the first line and 'do2' on the second line.</p>	<p>Press the "St" and "Bs" keys to return to the opening volume setting options screen, and use the "Up" and "Dn" keys to find the DO2 opening volume setting menu item. Use the "Up" and "Dn" buttons to locate the DO2 open volume setting menu item.</p>
<p>The LCD display shows the text 'do' on the first line and 'chn2' on the second line.</p>	<p>Press the "St" key to display the DO2 output parameter setting interface, the default is the DO2 output parameter channel selection menu item.</p>
<p>The LCD display shows the text 'do' on the first line, 'chn2' on the second line, and 'no' on the third line. The 'no' is highlighted in red.</p>	<p>Press the "St" key to display the DO1 parameter channel setting interface, and use the "Up" and "Dn" keys to set the desired channel parameter (setting value: all power parameters are optional; no is remote control output).</p>
<p>The LCD display shows the text 'do' on the first line and 'dEL2' on the second line.</p>	<p>Press the "St" key to return to the DO2 output parameter setting interface, and use the "Up" and "Dn" keys to find the DO2 parameter setting menu item.</p>
<p>The LCD display shows the text 'do' on the first line, 'dEL2' on the second line, and '1500' on the third line. The '1500' is highlighted in red.</p>	<p>Press the "St" key to display the parameter setting option interface, through the "Up" and "Dn" keys, set the parameters of DO2 channel (setting value: change based on the default parameter values, such as (Setting value: change based on the default parameter value, e.g., the lower limit value of voltage is 150V by default).</p>

	<p>After setting, press "St" key to confirm the setting, press "Bs" key continuously to select "y" blinking, and press "St" key to confirm the saving parameters. Press "Bs" key continuously to select "y" blinking, and press "St" key to confirm to save the parameter.</p>
---	--



3.4.6 Transmission parameter setting

	<p>Enter the user parameter setting interface, press "Dn" key to find the parameter setting menu item interface.</p>
	<p>Press the "St" key to display the variable output setting option interface, and use the "Up" and "Dn" keys to find the variable output channel setting menu item.</p>
	<p>Press the "St" key to display the channel setting interface of the transmission parameters, and set the required channel parameters by using the "Up" and "Dn" keys (setting value: all power parameters are optional).</p>
	<p>Press the "St" key to display the variable output setting option interface, and use the "Up" and "Dn" keys to find the variable output upper limit setting menu item.</p>

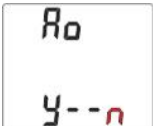
	<p>Press the "St" key to display the upper limit setting interface of variable output, and set the desired upper limit parameter through the "Up" and "Dn" keys (setting value: 4-20; default 20).).</p>
	<p>Press the "St" key to return to the variable output setting option interface, and use the "Up" and "Dn" keys to find the variable output lower limit setting menu item.</p>
	<p>Press "St" key to display the lower limit setting interface of transformer output, through "Up" and "Dn" keys, set the desired lower limit value parameter (setting value: 4-20; default 4). The lower limit setting interface is displayed.</p>
	<p>Press the "St" key to return to the Variable Transmission Setting Options screen, and use the "Up" and "Dn" keys to find the Variable Transmission Channel Parameter Upper Limit Setting menu item.</p>
	<p>Press "St" key to display the upper limit setting interface of transmission parameters, set the required parameters by "Up" and "Dn" keys (setting value: change based on the default parameter value, e.g. the upper limit value of transmission is 230V by default).</p>
	<p>Press the "St" key to return to the variable transmission setting option interface, and use the "Up" and "Dn" keys to find the lower limit setting menu item of the variable transmission channel parameters.</p>

	<p>Press "St" key to display the lower limit setting interface of transmission parameters, set the required parameters by "Up" and "Dn" keys (setting value: change based on the default parameter value, e.g. the lower limit value of transmission is 0.0V by default). (Setting value: change based on the default parameter value, e.g. the default value of lower limit of variable transmission is 0.0V).</p>
	<p>After setting, press "St" key to confirm the setting, press "Bs" key continuously to select "y" blinking, and press "St" key to confirm the saving parameters. Press "Bs" key continuously to select "y" blinking, and press "St" key to confirm to save the parameter.</p>

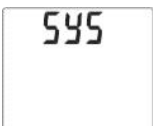
3.4.7 User Password Setting

	<p>Enter the user parameter setting interface, press the "Dn" key to find the system parameter setting menu item interface.</p>
	<p>Press the "St" key to display the system parameter setting interface, and use the "Up" and "Dn" keys to find the user password menu item.</p>
	<p>Press the "St" key to display the user password setting interface, and use the "Up" and "Dn" keys to set the desired new user password.</p>

	<p>After setting, press "St" key to confirm the setting, press "Bs" key continuously to select "y" blinking, and press "St" key to confirm the saving parameters. Press "Bs" key continuously to select "y" blinking, and press "St" key to confirm to save the parameter.</p>
--	--

English correspondence table of digital tubes

1	2	3	4	5	6	7	8	9	0	A	B
1	2	3	4	5	6	7	8	9	0	A	B
C	D	E	F	G	H	I	J	K	L	M	N
C	d	E	F	G	H	I	J	K	L	M	N
O	P	Q	R	S	T	U	V	W	X	Y	Z
o	P	q	r	s	t	u	v	w	x	y	z

After-sales service

1. If the user does not understand the description in the manual during installation and commissioning, please contact the technical director.
2. The company's technology is ready to answer product-related questions.
3. The problems arising in the use of the product will be replied within one working day.
4. Our company has a one-year free warranty for the above products from the date of sale.

Technical descriptions are subject to change without notice

Hangzhou Anting Electric Power Technology Co., Ltd

Hangzhou Antin Power Technology Co.,Ltd.

R&D headquarters: 8th floor, Lufang Science and Technology Innovation Building,
Xihu District, Hangzhou City, Zhejiang Province

Intelligent manufacturing base: 4th Floor, Building 3, Block C, Qinglan Science and
Technology Innovation Park, Xihu District, Hangzhou City, Zhejiang Province

Tel: 0571-87671599 87671596

Fax: 0571-87381800

National service telephone: 400-100-6818

Email: service@antinpower.com

Website: <http://www.antinpower.com>